

DATA TRANSMISSION

Concept of Transmission

Data transmission is the process of sending digital or analog data over a communication medium to one or more computing, network, communication or electronic devices.

It enables the transfer and communication of devices in a point-to-point, point-to-multipoint and multipoint-to-multipoint data streams or channels environment

Data transmission is also known as digital transmission or digital communications.

data transmission methods can refer to both analog and digital data, we will be focusing on digital modulation

This modulation technique focuses on the encoding and decoding of digital signals via two main methods parallel and serial transmission.

Types of Data Transmission

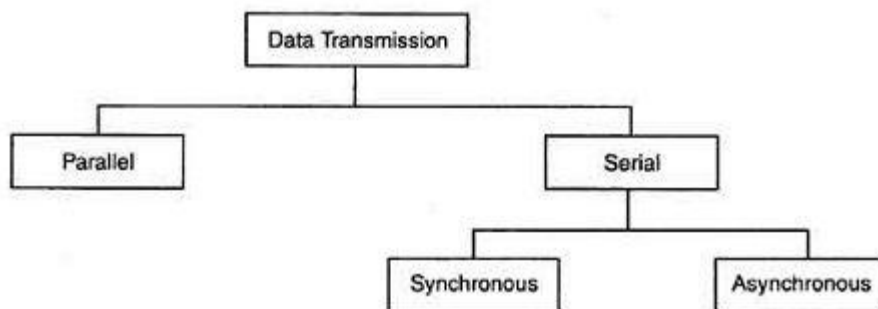

What is parallel transmission?

When data is sent using parallel data transmission, multiple data bits are transmitted over multiple channels at the same time. This means that data can be sent much faster than using serial transmission methods.

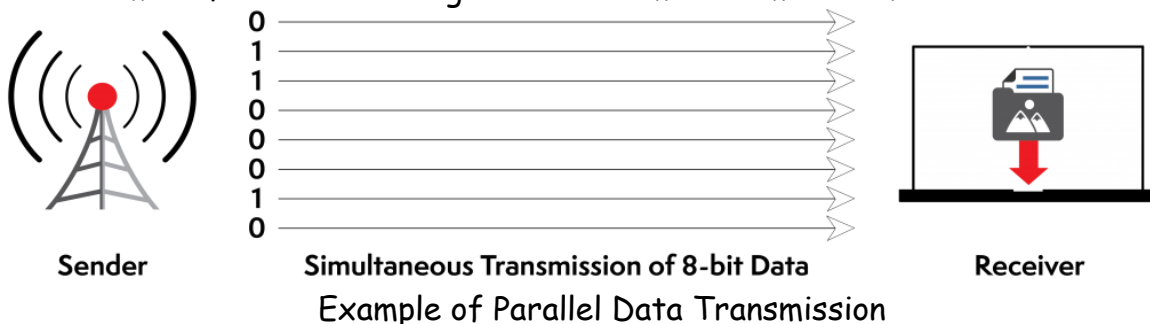

Given that multiple bits are sent over multiple channels at the same time, the order in which a bit string is received can depend on various conditions, such as proximity to the data source, user location, and bandwidth availability.

Two examples of parallel interfaces can be seen below. In the first parallel interface, the data is sent and received in the correct order.

In the second parallel interface, the data is sent in the correct order, but some bits were received faster than others.

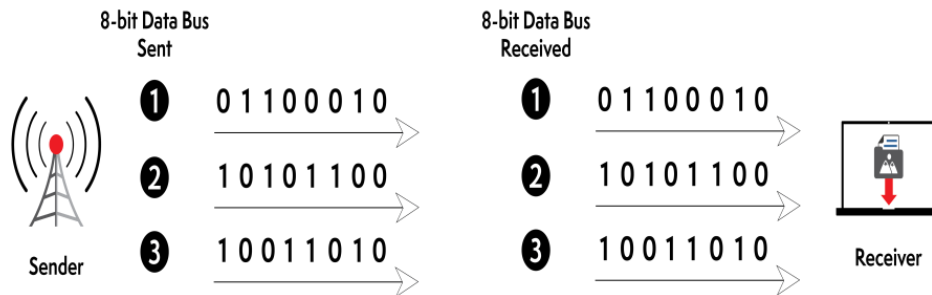

Example of Parallel Transmission - Data Received Correctly

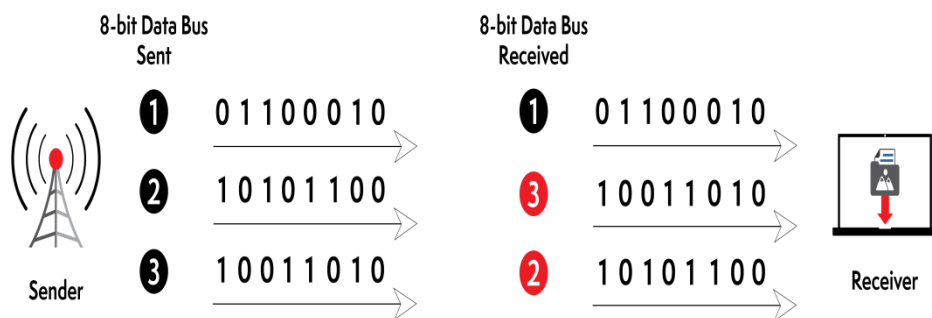

Example of Parallel Transmission - Data Received Incorrectly

Advantages and Disadvantages of Using Parallel Data Transmission

The main advantages of parallel transmission over serial transmission are:

- it is easier to program;
- and data is sent faster.

Although parallel transmission can transfer data faster, it requires more transmission channels than serial transmission. This means that data bits can be out of sync, depending on transfer distance and how fast each bit loads.

A simple example of where this can be seen is with a voice over IP (VOIP) call when distortion or interference is noticeable. It can also be seen when there is skipping or interference on a video stream.

Parallel transmission is used when:

- a large amount of data is being sent;
- the data being sent is time-sensitive;

- and the data needs to be sent quickly.

What is serial transmission?

When data is sent or received using serial data transmission, the data bits are organized in a specific order, since they can only be sent one after another.

The order of the data bits is important as it dictates how the transmission is organized when it is received.

It is viewed as a reliable data transmission method because a data bit is only sent if the previous data bit has already been received.

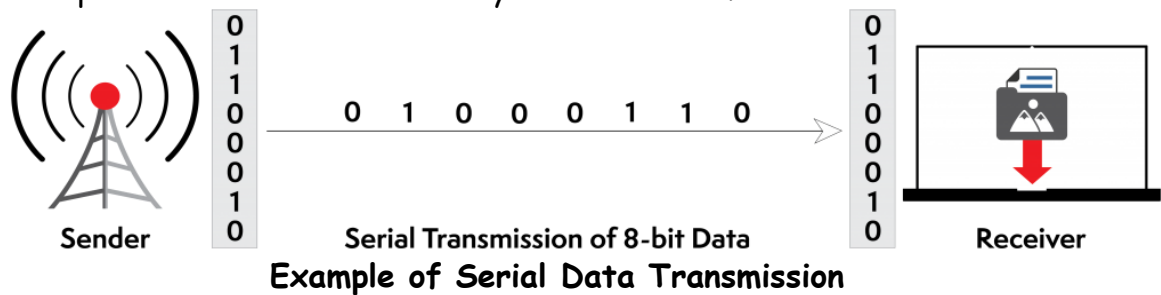

- Serial transmission has two classifications: asynchronous and synchronous.

Asynchronous Serial Transmission

Data bits can be sent at any point in time. Stop bits and start bits are used between data bytes to synchronize the transmitter and receiver and to ensure that the data is transmitted correctly. The time between sending and receiving data bits is not constant, so gaps are used to provide time between transmissions.

The advantage of using the asynchronous method is that no synchronization is required between the transmitter and receiver devices. It is also a more cost effective method.

A disadvantage is that data transmission can be slower, but this is not always the case.

Synchronous Serial Transmission

Data bits are transmitted as a continuous stream in time with a master clock. The data transmitter and receiver both operate using a synchronized clock frequency; therefore, start bits, stop bits, and gaps are not used.

This means that data moves faster and timing errors are less frequent because the transmitter and receiver time is synced. However, data accuracy is highly

dependent on timing being synced correctly between devices. In comparison with asynchronous serial transmission, this method is usually more expensive.

TERMINOLOGY

Faster Data Transfer

FTP and HTTP are common methods of file transfer. FTP can be used to transfer files or access online software archives, for example. HTTP is the protocol used to indicate how messages are not only defined, but also transmitted.

It also determines what actions web browsers and servers take to respond to a variety of commands.

HTTP requests are identified as a stateless protocol, meaning they have no information regarding previous requests.

ISPs offer finite levels of bandwidth for both sending and receiving data communications, which can cause excessive slowdowns a business just cannot afford.

A content delivery network like CD Networks provides data transfer that is 100X faster than both FTP and HTTP methods, whether transferring a massive media file or multiple smaller files.

Transfer Rates

High data transfer rates are essential for any business. To determine how fast data is transferred from one network location to another, the data are measured using the transfer rate in bits per second (bps).

Bandwidth refers to the maximum amount of data that can be transferred within a given amount of time. One of the most promising innovations implemented by content network services is Tbps (Terabits Per Second), which was unimaginable up until the early part of the decade, and can lead to almost real-time communication between devices.

CDNetworks offers a 50 Tbps bandwidth capacity to ensure high-quality data transfer for media delivery and other large capacity content. CDNetworks transmits and merges data using multiple paths to increase the speed of data transmission.

Big Data

Because of the rise in mobile usage, social media, and a variety of sensors, the amount of data used annually has expanded by as much as 40 percent year over year, according to industry researchers.

More than ever, high-speed data transmission infrastructure is needed by businesses in every industry to handle the ever-increasing volume of content transferred from one point to the next.

ANALOG DATA TRANSMISSION

To send the digital data over an analog media, it needs to be converted into analog signal. There can be two cases according to data formatting.

Bandpass: The filters are used to filter and pass frequencies of interest. A bandpass is a band of frequencies which can pass the filter.

Low-pass: Low-pass is a filter that passes low frequencies signals.

When digital data is converted into a bandpass analog signal, it is called digital-to-analog conversion. When low-pass analog signal is converted into bandpass analog signal, it is called analog-to-analog conversion.

Digital-to-Analog Conversion

When data from one computer is sent to another via some analog carrier, it is first converted into analog signals. Analog signals are modified to reflect digital data.

An analog signal is characterized by its amplitude, frequency, and phase. There are three kinds of digital-to-analog conversions:

- **Amplitude Shift Keying**

In this conversion technique, the amplitude of analog carrier signal is modified to reflect binary data.

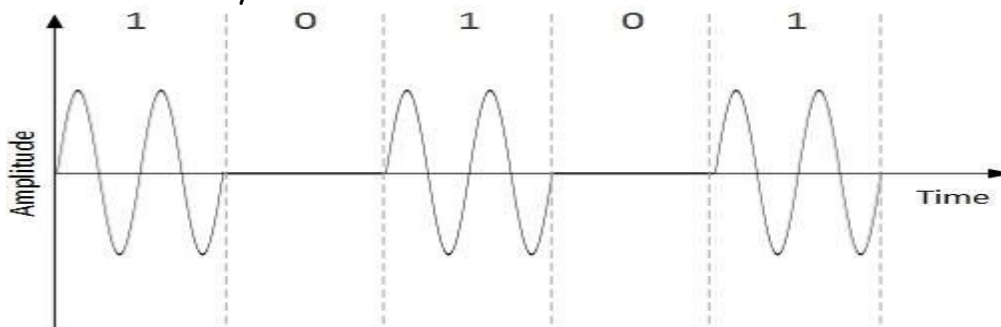

When binary data represents digit 1, the amplitude is held; otherwise it is set to 0. Both frequency and phase remain same as in the original carrier signal.

- **Frequency Shift Keying**

In this conversion technique, the frequency of the analog carrier signal is modified to reflect binary data.

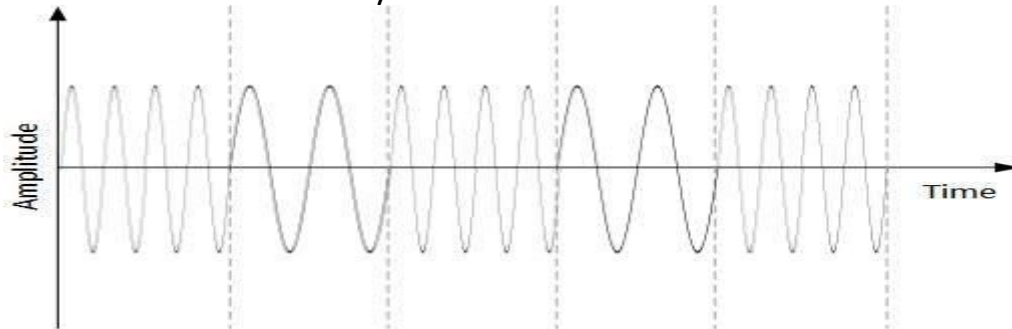

This technique uses two frequencies, f_1 and f_2 . One of them, for example f_1 , is chosen to represent binary digit 1 and the other one is used to represent binary digit 0. Both amplitude and phase of the carrier wave are kept intact.

- **Phase Shift Keying**

In this conversion scheme, the phase of the original carrier signal is altered to reflect the binary data.

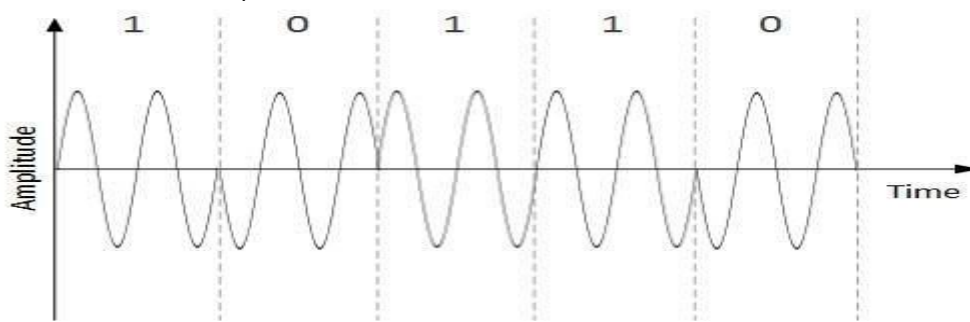

When a new binary symbol is encountered, the phase of the signal is altered. Amplitude and frequency of the original carrier signal is kept intact.

- **Quadrature Phase Shift Keying**

QPSK alters the phase to reflect two binary digits at once. This is done in two different phases. The main stream of binary data is divided equally into two sub-streams. The serial data is converted into parallel in both sub-streams and then each stream is converted to digital signal using NRZ technique. Later, both the digital signals are merged together.

Analog-to-Analog Conversion

Analog signals are modified to represent analog data. This conversion is also known as Analog Modulation. Analog modulation is required when bandpass is used. Analog to analog conversion can be done in three ways:

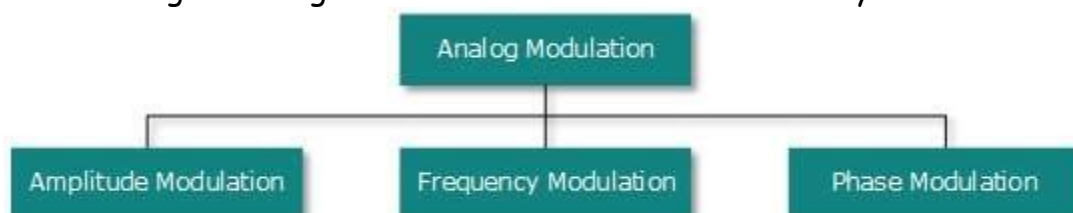

- **Amplitude Modulation**

In this modulation, the amplitude of the carrier signal is modified to reflect the analog data.

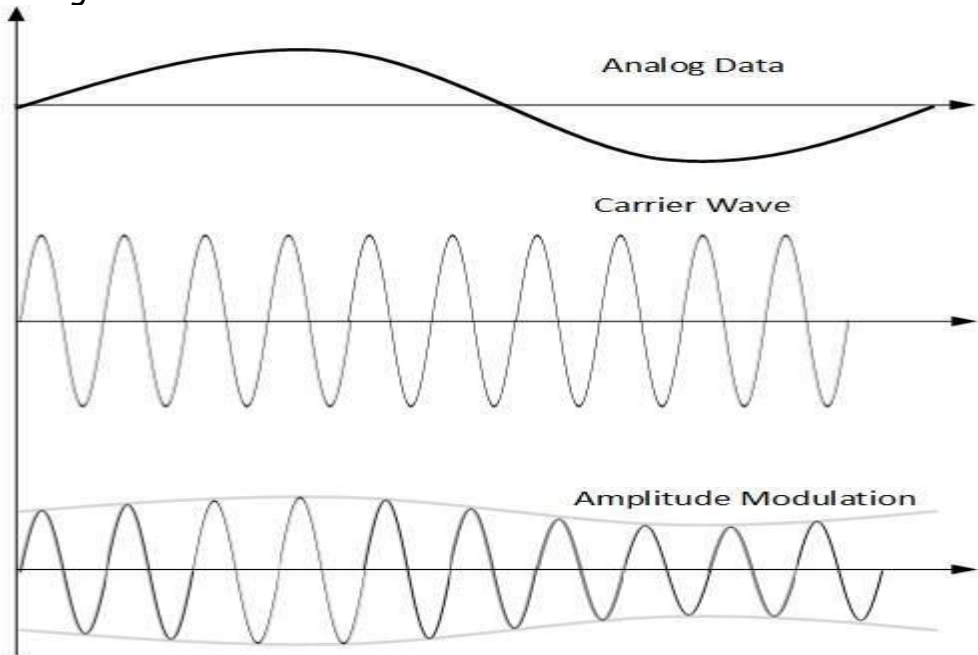

Amplitude modulation is implemented by means of a multiplier. The amplitude of modulating signal (analog data) is multiplied by the amplitude of carrier frequency, which then reflects analog data.

The frequency and phase of carrier signal remain unchanged.

- **Frequency Modulation**

In this modulation technique, the frequency of the carrier signal is modified to reflect the change in the voltage levels of the modulating signal (analog data).

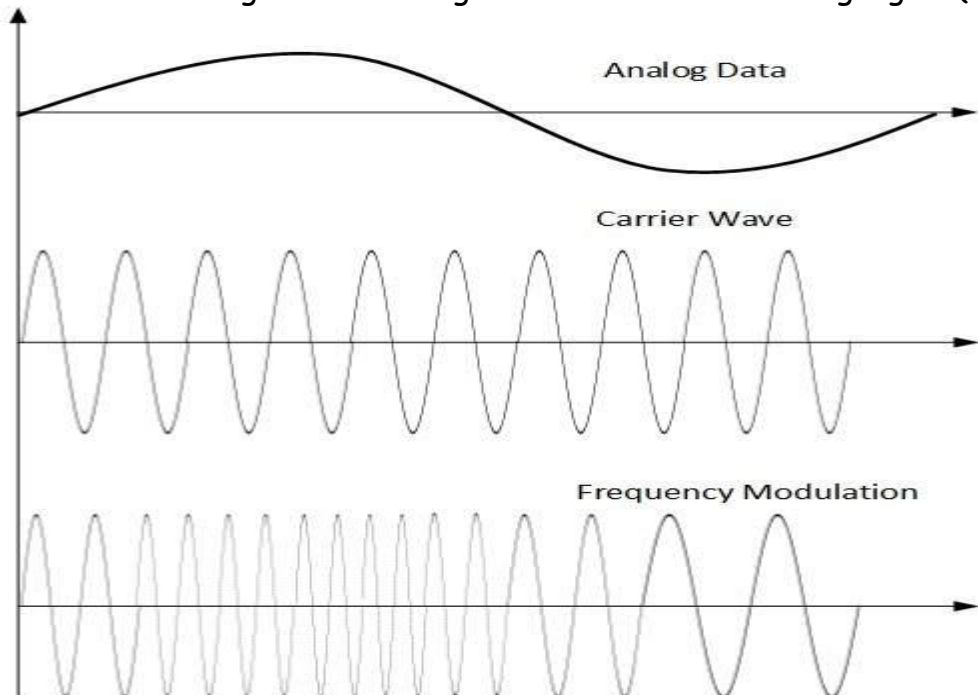

The amplitude and phase of the carrier signal are not altered.

- **Phase Modulation**

In the modulation technique, the phase of carrier signal is modulated in order to reflect the change in voltage (amplitude) of analog data signal.

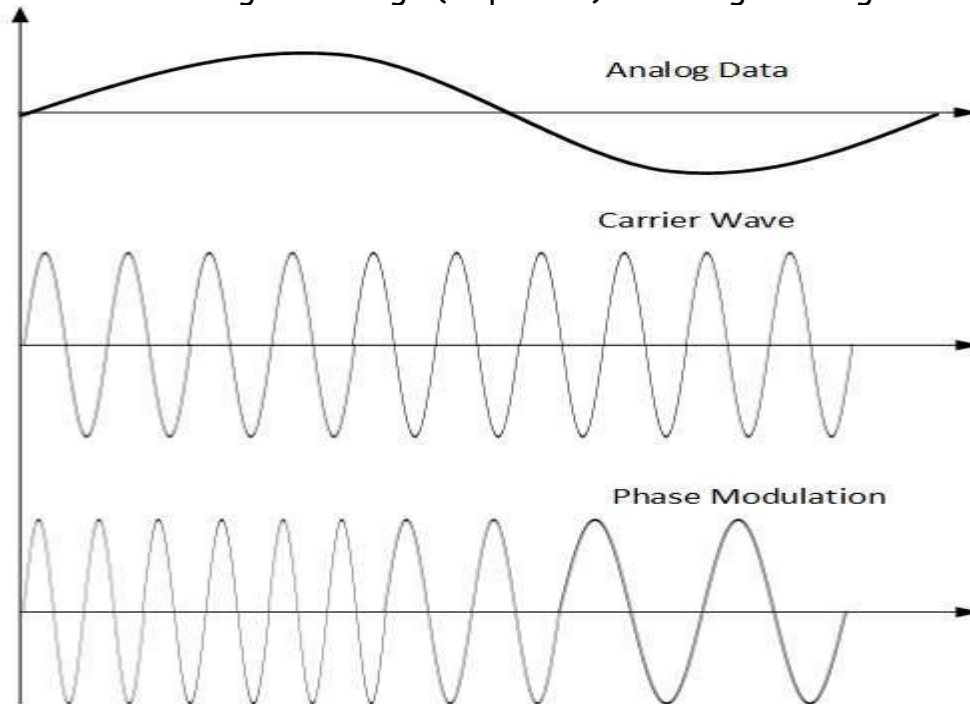

Phase modulation is practically similar to Frequency Modulation, but in Phase modulation frequency of the carrier signal is not increased. Frequency of carrier is signal is changed (made dense and sparse) to reflect voltage change in the amplitude of modulating signal

DIGITAL DATA TRANSMISSION

Data or information can be stored in two ways, analog and digital. For a computer to use the data, it must be in discrete digital form.

Similar to data, signals can also be in analog and digital form. To transmit data digitally, it needs to be first converted to digital form.

Digital-to-Digital Conversion

This section explains how to convert digital data into digital signals. It can be done in two ways, line coding and block coding. For all communications, line coding is necessary whereas block coding is optional.

Line Coding

The process for converting digital data into digital signal is said to be Line Coding. Digital data is found in binary format. It is represented (stored) internally as series of 1s and 0s.

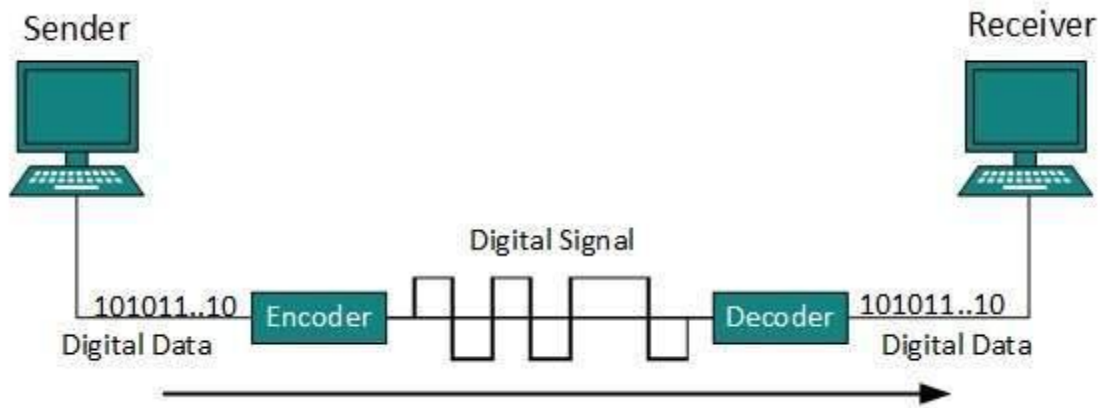

Digital signal is denoted by discrete signal, which represents digital data. There are three types of line coding schemes available:

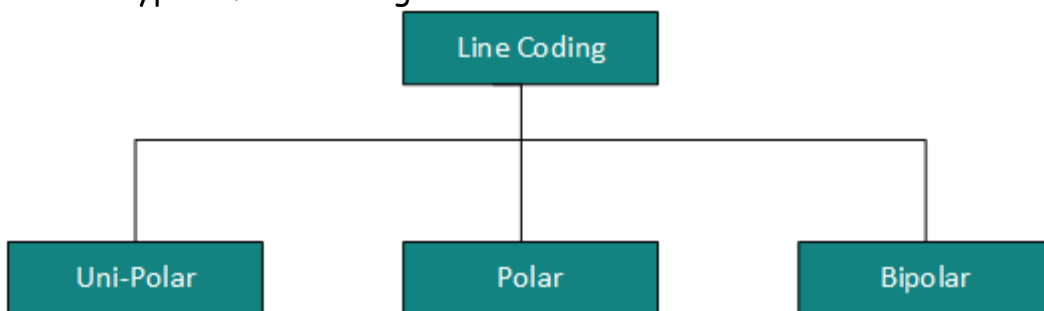

Uni-polar Encoding

Unipolar encoding schemes use single voltage level to represent data. In this case, to represent binary 1, high voltage is transmitted and to represent 0, no voltage is transmitted. It is also called Unipolar-Non-return-to-zero, because there is no rest condition i.e. it either represents 1 or 0.

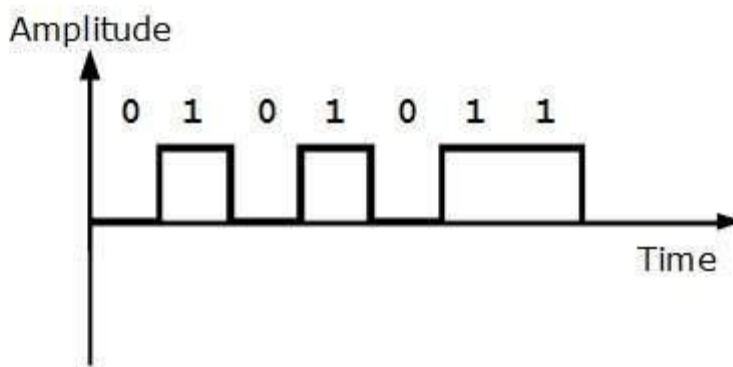

Polar Encoding

Polar encoding scheme uses multiple voltage levels to represent binary values. Polar encodings is available in four types:

- **Polar Non-Return to Zero (Polar NRZ)**

It uses two different voltage levels to represent binary values. Generally, positive voltage represents 1 and negative value represents 0. It is also NRZ because there is no rest condition.

NRZ scheme has two variants: NRZ-L and NRZ-I.

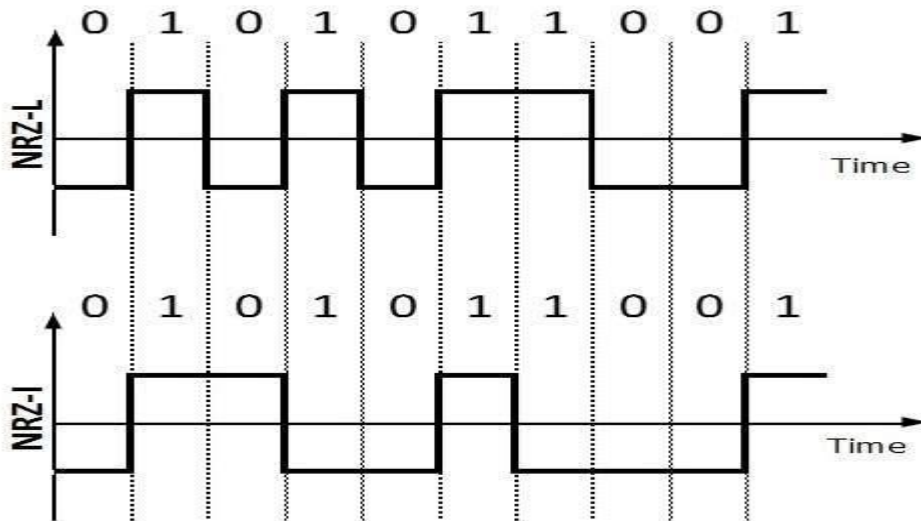

NRZ-L changes voltage level at when a different bit is encountered whereas NRZ-I changes voltage when a 1 is encountered.

- **Return to Zero (RZ)**

Problem with NRZ is that the receiver cannot conclude when a bit ended and when the next bit is started, in case when sender and receiver's clock are not synchronized.

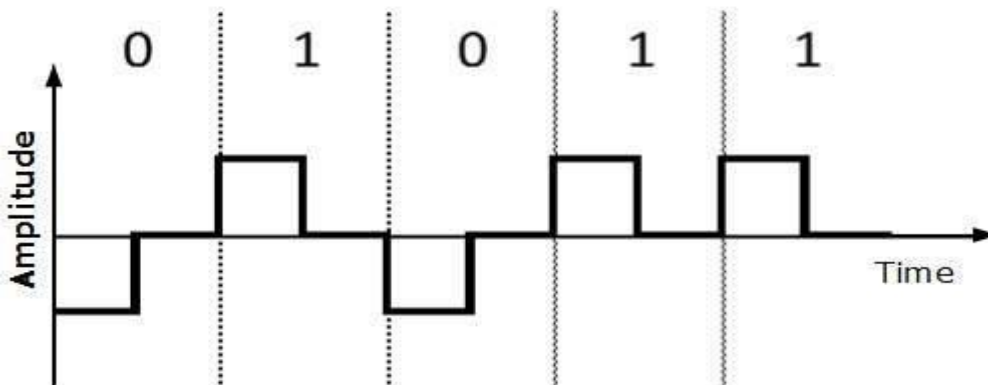

RZ uses three voltage levels, positive voltage to represent 1, negative voltage to represent 0 and zero voltage for none. Signals change during bits not between bits.

- **Manchester**

This encoding scheme is a combination of RZ and NRZ-L. Bit time is divided into two halves. It transits in the middle of the bit and changes phase when a different bit is encountered.

- **Differential Manchester**

This encoding scheme is a combination of RZ and NRZ-I. It also transit at the middle of the bit but changes phase only when 1 is encountered.

Bipolar Encoding

Bipolar encoding uses three voltage levels, positive, negative and zero. Zero voltage represents binary 0 and bit 1 is represented by altering positive and negative voltages.

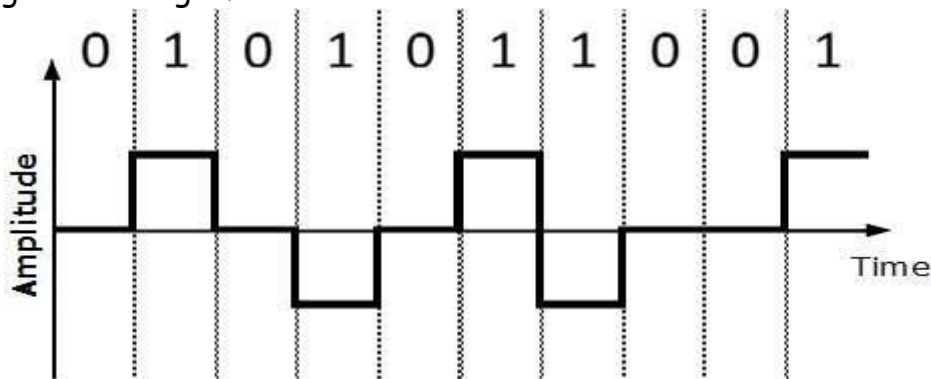

Block Coding

To ensure accuracy of the received data frame redundant bits are used. For example, in even-parity, one parity bit is added to make the count of 1s in the frame even. This way the original number of bits is increased. It is called Block Coding.

Block coding is represented by slash notation, mB/nB . Means, m -bit block is substituted with n -bit block where $n > m$. Block coding involves three steps:

- Division,
- Substitution
- Combination.

After block coding is done, it is line coded for transmission.

Analog-to-Digital Conversion

Microphones create analog voice and camera creates analog videos, which are treated as analog data. To transmit this analog data over digital signals, we need analog to digital conversion.

Analog data is a continuous stream of data in the wave form whereas digital data is discrete. To convert analog wave into digital data, we use Pulse Code Modulation (PCM).

PCM is one of the most commonly used method to convert analog data into digital form. It involves three steps:

- Sampling
- Quantization
- Encoding.

Sampling

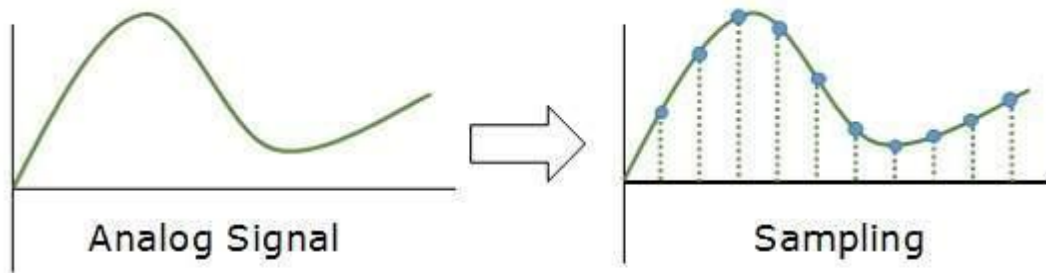

The analog signal is sampled every T interval. Most important factor in sampling is the rate at which analog signal is sampled. According to Nyquist Theorem, the sampling rate must be at least two times of the highest frequency of the signal.

Quantization

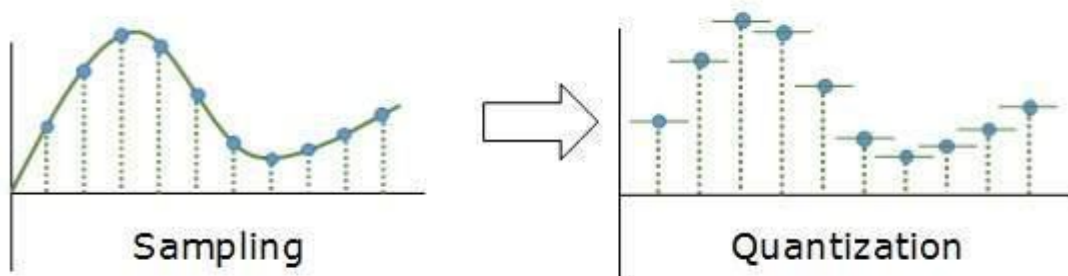

Sampling yields discrete form of continuous analog signal. Every discrete pattern shows the amplitude of the analog signal at that instance. The quantization is done between the maximum amplitude value and the minimum amplitude value. Quantization is approximation of the instantaneous analog value.

Encoding

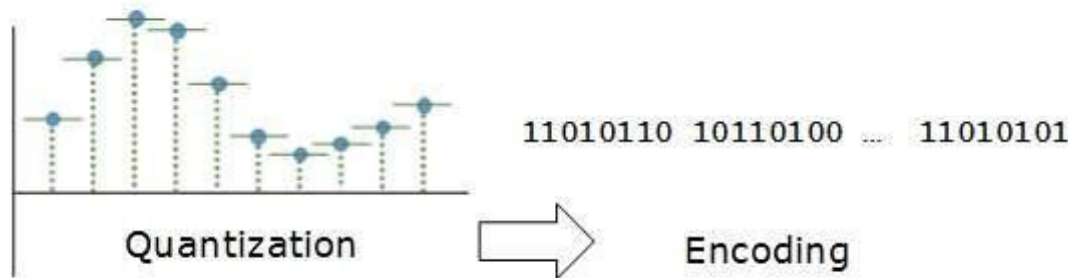

In encoding, each approximated value is then converted into binary format.

CHANNEL CAPACITY

The maximum quantity of traffic or signal that may pass over a particular infrastructure channel is channel capacity. It can be used to assess the capacity of a channel or conduit in computer science, electrical engineering, and other areas.

The apparent advantages of analyzing channel analysis have made this word a household term in the IT world. Engineers might be tasked with determining how much data can flow through a particular fiber-optic network or how much data can pass via a WAN with wired and wireless components. The difficulty of deciding channel capacity and the level of precision required may vary depending on the system's requirements.

Engineers may focus on a particular section of a network regarded as a "bottleneck," or estimate standard channel capacity for broader reasons.

Engineers and others can use tools such as the Shannon-Hartley theorem to determine channel volume where there are mitigation factors; in this case, the volume of the upper channel after the calculation of a certain level of signal sound.

Types of Communication Channel

There are three types of communication channels in computer networking -

- **Simplex channel** - Signals can only be sent in one way using a simple communication connection. As a result, the channel's complete bandwidth can be used during transmission.
- **Half-duplex channel** - A half-duplex communication channel can send signals in both directions simultaneously, but only in one. It can be thought of as a simplex communication channel with a switchable transmission direction.
- **Full-duplex channel** - A full-duplex communication link can simultaneously send signals in both directions. Communication efficiency is considerably improved by using full-duplex communication channels.

Two factors determine the channel's capacity -

- Bandwidth
- Delay in propagation

In the event of a half-duplex, the capacity of a network is equal to the bandwidth multiplied by the propagation delay. In the event of a full duplex, the capacity is twice the multiplication of the bandwidth and the propagation delay.

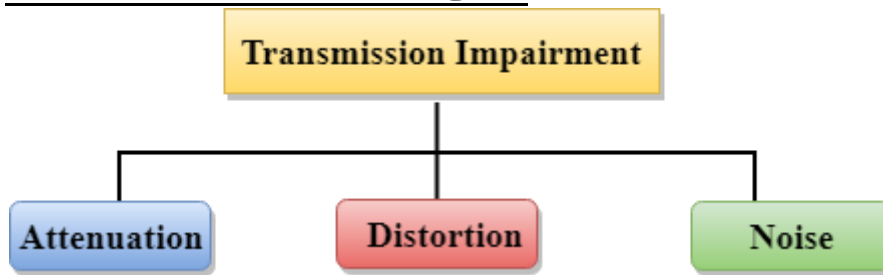
TRANSMISSION IMPAIRMENT:

- **Attenuation:** Attenuation means the loss of energy, i.e., the strength of the signal decreases with increasing the distance which causes the loss of energy.
- **Distortion:** Distortion occurs when there is a change in the shape of the signal. This type of distortion is examined from different signals having different frequencies. Each frequency component has its own propagation speed, so they reach at a different time which leads to the delay distortion.
- **Noise:** When data is travelled over a transmission medium, some unwanted signal is added to it which creates the noise.

TRANSMISSION MEDIA

- Transmission media is a communication channel that carries the information from the sender to the receiver. Data is transmitted through the electromagnetic signals.
- The main functionality of the transmission media is to carry the information in the form of bits through **LAN**(Local Area Network).
- It is a physical path between transmitter and receiver in data communication.
- In a copper-based network, the bits in the form of electrical signals.
- In a fibre based network, the bits in the form of light pulses.
- In **OSI**(Open System Interconnection) phase, transmission media supports the Layer 1. Therefore, it is considered to be as a Layer 1 component.
- The electrical signals can be sent through the copper wire, fibre optics, atmosphere, water, and vacuum.
- The characteristics and quality of data transmission are determined by the characteristics of medium and signal.
- Transmission media is of two types are wired media and wireless media. In wired media, medium characteristics are more important whereas, in wireless media, signal characteristics are more important.
- Different transmission media have different properties such as bandwidth, delay, cost and ease of installation and maintenance.
- The transmission media is available in the lowest layer of the OSI reference model, i.e., **Physical layer**.

Classification Of Transmission Media:

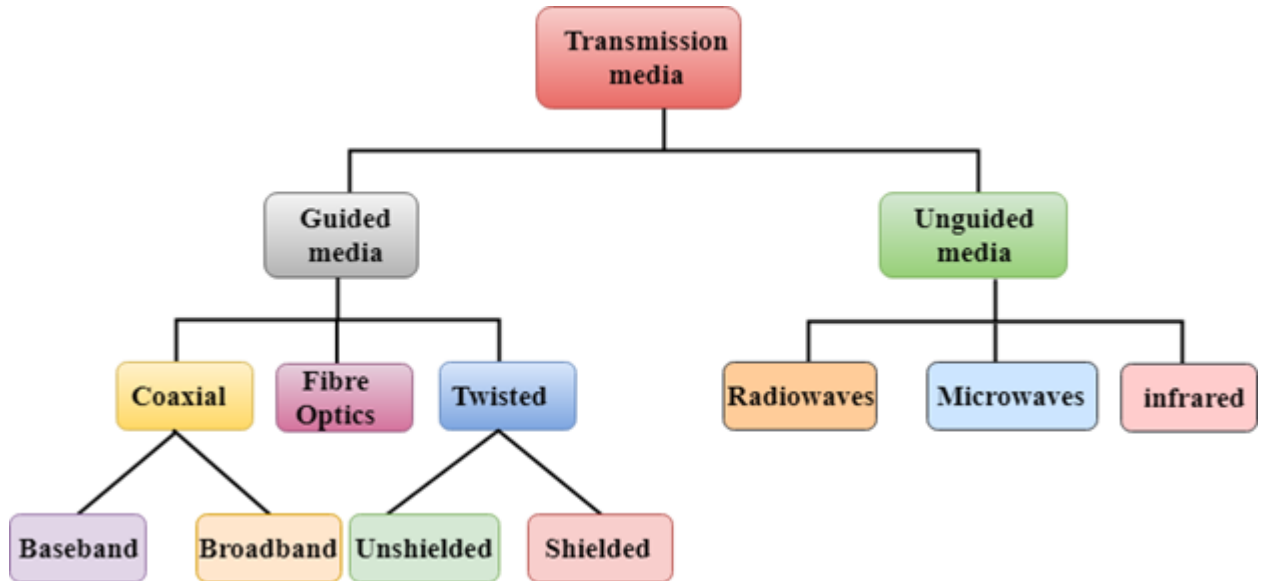

- Guided Transmission Media
- UnGuided Transmission Media

Guided Media

It is defined as the physical medium through which the signals are transmitted. It is also known as Bounded media.

Types Of Guided media:

Twisted pair:

- Twisted pair is a physical media made up of a pair of cables twisted with each other. A twisted pair cable is cheap as compared to other transmission media. Installation of the twisted pair cable is easy, and it is a lightweight cable. The frequency range for twisted pair cable is from 0 to 3.5KHz.
- A twisted pair consists of two insulated copper wires arranged in a regular spiral pattern.
- The degree of reduction in noise interference is determined by the number of turns per foot. Increasing the number of turns per foot decreases noise interference.

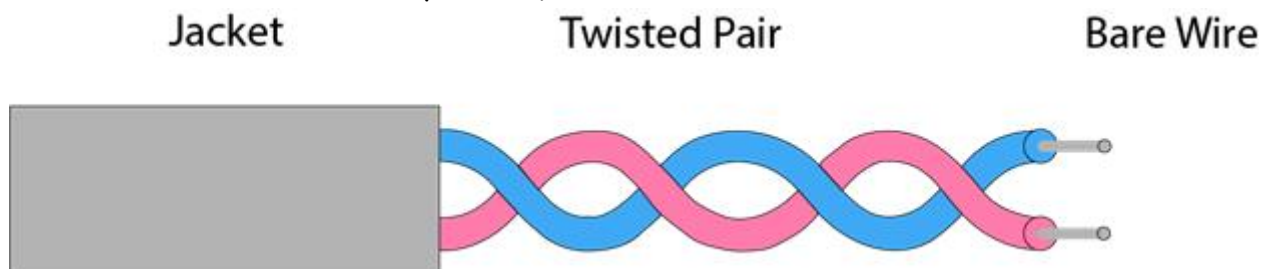

Types of Twisted pair:

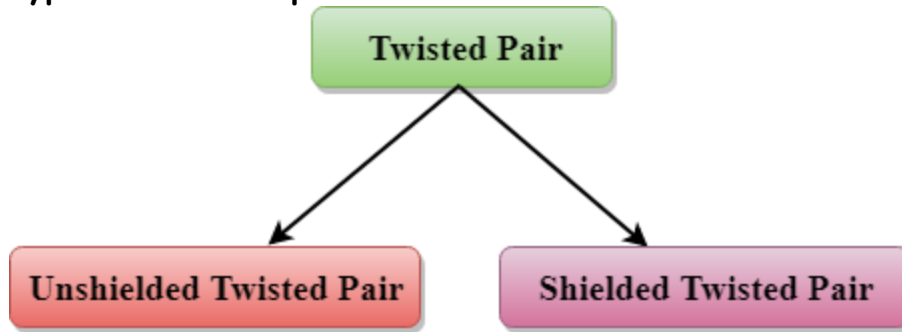

Unshielded Twisted Pair:

An unshielded twisted pair is widely used in telecommunication. Following are the categories of the unshielded twisted pair cable:

- **Category 1:** Category 1 is used for telephone lines that have low-speed data.
- **Category 2:** It can support upto 4Mbps.
- **Category 3:** It can support upto 16Mbps.
- **Category 4:** It can support upto 20Mbps. Therefore, it can be used for long-distance communication.
- **Category 5:** It can support upto 200Mbps.

Advantages Of Unshielded Twisted Pair:

- It is cheap.
- Installation of the unshielded twisted pair is easy.
- It can be used for high-speed LAN.

Disadvantage:

- This cable can only be used for shorter distances because of attenuation.

Shielded Twisted Pair

A shielded twisted pair is a cable that contains the mesh surrounding the wire that allows the higher transmission rate.

Characteristics Of Shielded Twisted Pair:

- The cost of the shielded twisted pair cable is not very high and not very low.
- An installation of STP is easy.
- It has higher capacity as compared to unshielded twisted pair cable.
- It has a higher attenuation.
- It is shielded that provides the higher data transmission rate.

Disadvantages

- It is more expensive as compared to UTP and coaxial cable.
- It has a higher attenuation rate.

Coaxial Cable

- Coaxial cable is very commonly used transmission media, for example, TV wire is usually a coaxial cable.
- The name of the cable is coaxial as it contains two conductors parallel to each other.
- It has a higher frequency as compared to Twisted pair cable.
- The inner conductor of the coaxial cable is made up of copper, and the outer conductor is made up of copper mesh. The middle core is made up of non-conductive cover that separates the inner conductor from the outer conductor.
- The middle core is responsible for the data transferring whereas the copper mesh prevents from the **EMI**(Electromagnetic interference).

Jacket Shield Insulator Centre Conductor

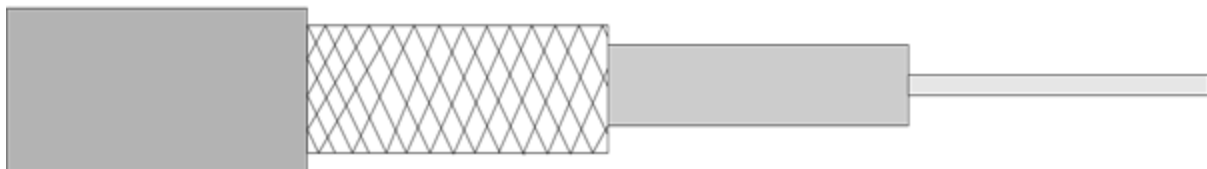

Coaxial cable is of two types:

1. **Baseband transmission:** It is defined as the process of transmitting a single signal at high speed.
2. **Broadband transmission:** It is defined as the process of transmitting multiple signals simultaneously.

Advantages Of Coaxial cable:

- The data can be transmitted at high speed.
- It has better shielding as compared to twisted pair cable.
- It provides higher bandwidth.

Disadvantages Of Coaxial cable:

- It is more expensive as compared to twisted pair cable.
- If any fault occurs in the cable causes the failure in the entire network.

Fibre Optic

- Fibre optic cable is a cable that uses electrical signals for communication.
- Fibre optic is a cable that holds the optical fibres coated in plastic that are used to send the data by pulses of light.
- The plastic coating protects the optical fibres from heat, cold, electromagnetic interference from other types of wiring.
- Fibre optics provide faster data transmission than copper wires.

Diagrammatic representation of fibre optic cable:

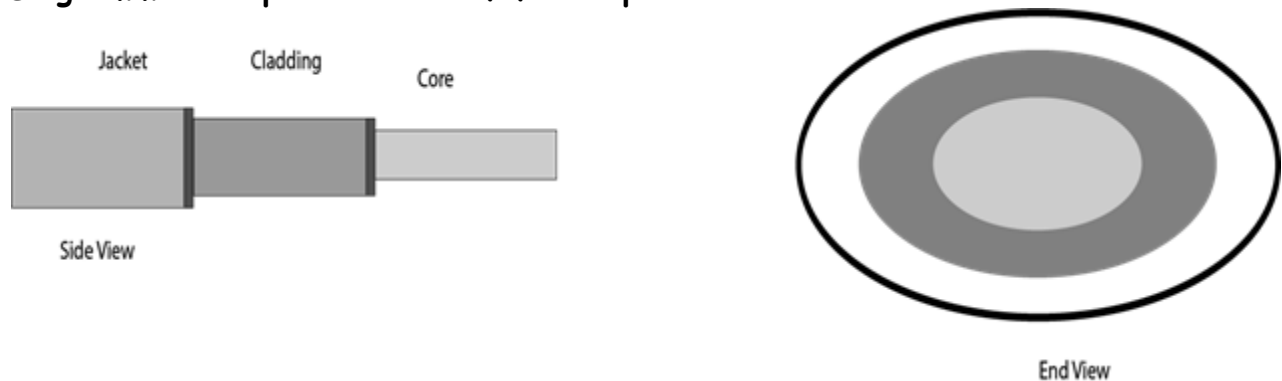

Basic elements of Fibre optic cable:

- **Core:** The optical fibre consists of a narrow strand of glass or plastic known as a core. A core is a light transmission area of the fibre. The more the area of the core, the more light will be transmitted into the fibre.
- **Cladding:** The concentric layer of glass is known as cladding. The main functionality of the cladding is to provide the lower refractive index at the core interface as to cause the reflection within the core so that the light waves are transmitted through the fibre.
- **Jacket:** The protective coating consisting of plastic is known as a jacket. The main purpose of a jacket is to preserve the fibre strength, absorb shock and extra fibre protection.

Following are the advantages of fibre optic cable over copper:

- **Greater Bandwidth:** The fibre optic cable provides more bandwidth as compared copper. Therefore, the fibre optic carries more data as compared to copper cable.
- **Faster speed:** Fibre optic cable carries the data in the form of light. This allows the fibre optic cable to carry the signals at a higher speed.
- **Longer distances:** The fibre optic cable carries the data at a longer distance as compared to copper cable.
- **Better reliability:** The fibre optic cable is more reliable than the copper cable as it is immune to any temperature changes while it can cause obstruct in the connectivity of copper cable.
- **Thinner and Sturdier:** Fibre optic cable is thinner and lighter in weight so it can withstand more pull pressure than copper cable.

UNGUIDED TRANSMISSION (WIRELESS TRANSMISSION)

- An unguided transmission transmits the electromagnetic waves without using any physical medium. Therefore it is also known as **wireless transmission**.
- In unguided media, air is the media through which the electromagnetic energy can flow easily.

Unguided transmission is broadly classified into three categories:

Radio waves

- Radio waves are the electromagnetic waves that are transmitted in all the directions of free space.
- Radio waves are omnidirectional, i.e., the signals are propagated in all the directions.
- The range in frequencies of radio waves is from 3Khz to 1 khz.
- In the case of radio waves, the sending and receiving antenna are not aligned, i.e., the wave sent by the sending antenna can be received by any receiving antenna.
- An example of the radio wave is **FM radio**.

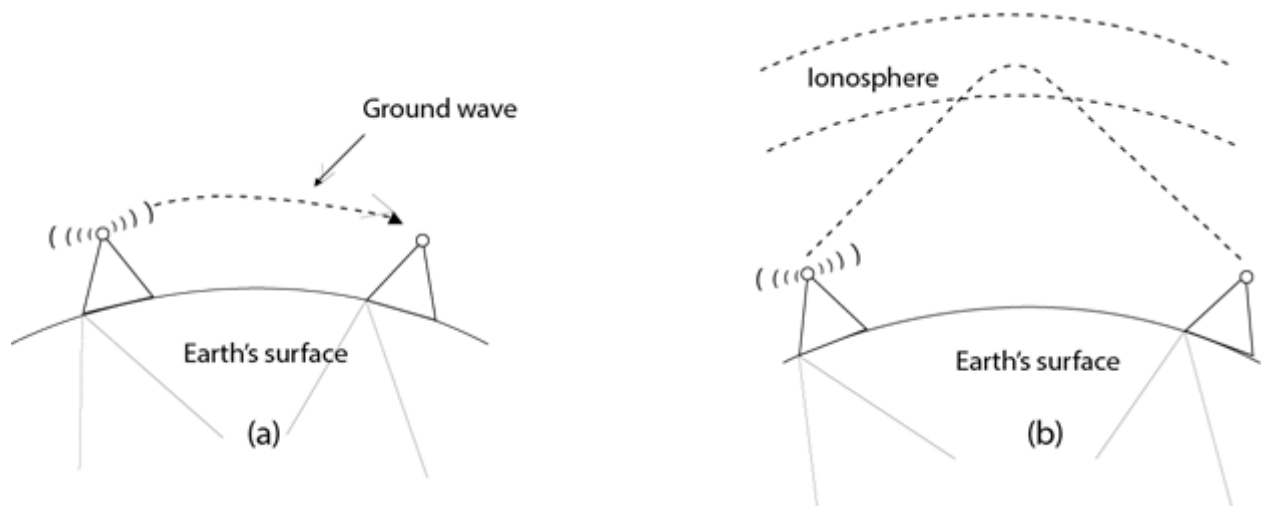

Applications Of Radio waves:

- A Radio wave is useful for multicasting when there is one sender and many receivers.
- An FM radio, television, cordless phones are examples of a radio wave.

Advantages Of Radio transmission:

- Radio transmission is mainly used for wide area networks and mobile cellular phones.
- Radio waves cover a large area, and they can penetrate the walls.
- Radio transmission provides a higher transmission rate.

Microwaves

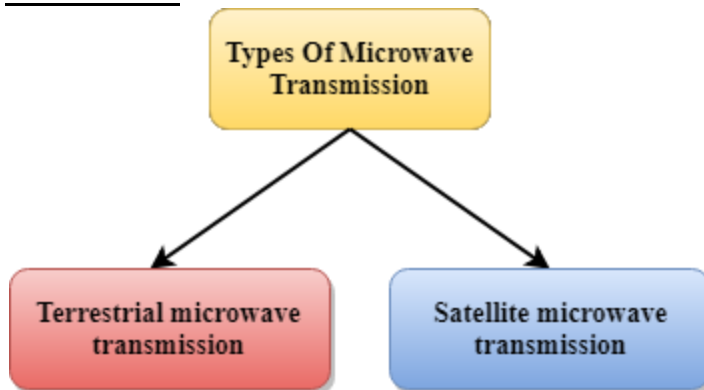

Microwaves are of two types:

- Terrestrial microwave
- Satellite microwave communication.

Terrestrial Microwave Transmission

- Terrestrial Microwave transmission is a technology that transmits the focused beam of a radio signal from one ground-based microwave transmission antenna to another.
- Microwaves are the electromagnetic waves having the frequency in the range from 1GHz to 1000 GHz.
- Microwaves are unidirectional as the sending and receiving antenna is to be aligned, i.e., the waves sent by the sending antenna are narrowly focussed.
- In this case, antennas are mounted on the towers to send a beam to another antenna which is km away.
- It works on the line of sight transmission, i.e., the antennas mounted on the towers are the direct sight of each other.

Characteristics of Microwave:

- **Frequency range:** The frequency range of terrestrial microwave is from 4-6 GHz to 21-23 GHz.
- **Bandwidth:** It supports the bandwidth from 1 to 10 Mbps.
- **Short distance:** It is inexpensive for short distance.
- **Long distance:** It is expensive as it requires a higher tower for a longer distance.
- **Attenuation:** Attenuation means loss of signal. It is affected by environmental conditions and antenna size.

Advantages Of Microwave:

- Microwave transmission is cheaper than using cables.
- It is free from land acquisition as it does not require any land for the installation of cables.

- Microwave transmission provides an easy communication in terrains as the installation of cable in terrain is quite a difficult task.
- Communication over oceans can be achieved by using microwave transmission.

Disadvantages of Microwave transmission:

- **Eavesdropping:** An eavesdropping creates insecure communication. Any malicious user can catch the signal in the air by using its own antenna.
- **Out of phase signal:** A signal can be moved out of phase by using microwave transmission.
- **Susceptible to weather condition:** A microwave transmission is susceptible to weather condition. This means that any environmental change such as rain, wind can distort the signal.
- **Bandwidth limited:** Allocation of bandwidth is limited in the case of microwave transmission.

Satellite Microwave Communication

- A satellite is a physical object that revolves around the earth at a known height.
- Satellite communication is more reliable nowadays as it offers more flexibility than cable and fibre optic systems.
- We can communicate with any point on the globe by using satellite communication.

Infrared

- An infrared transmission is a wireless technology used for communication over short ranges.
- The frequency of the infrared in the range from 300 GHz to 400 THz.
- It is used for short-range communication such as data transfer between two cell phones, TV remote operation, data transfer between a computer and cell phone resides in the same closed area.

Characteristics Of Infrared:

- It supports high bandwidth, and hence the data rate will be very high.
- Infrared waves cannot penetrate the walls. Therefore, the infrared communication in one room cannot be interrupted by the nearby rooms.
- An infrared communication provides better security with minimum interference.
- Infrared communication is unreliable outside the building because the sun rays will interfere with the infrared waves.

WIRELESS PROPAGATION

Radio Wave Propagation

In **Radio communication systems**, we use wireless electromagnetic waves as the channel. The antennas of different specifications can be used for these purposes. The sizes of these antennas depend upon the bandwidth and frequency of the signal to be transmitted.

The mode of propagation of electromagnetic waves in the atmosphere and in free space may be divided into the following three categories -

- Line of sight (LOS) propagation
- Ground wave propagation
- Sky wave propagation

In ELF (Extremely low frequency) and VLF (Very low frequency) frequency bands, the Earth, and the ionosphere act as a wave guide for electromagnetic wave propagation.

In these frequency ranges, communication signals practically propagate around the world. The channel bandwidths are small. Therefore, the information is transmitted through these channels has slow speed and confined to digital transmission.

Line of Sight (LOS) Propagation

Among the modes of propagation, this line-of-sight propagation is the one, which we commonly notice. In the **line-of-sight communication**, as the name implies, the wave travels a minimum distance of sight. Which means it travels to the distance up to which a naked eye can see. Now what happens after that? We need to employ an amplifier cum transmitter here to amplify the signal and transmit again.

This is better understood with the help of the following diagram.

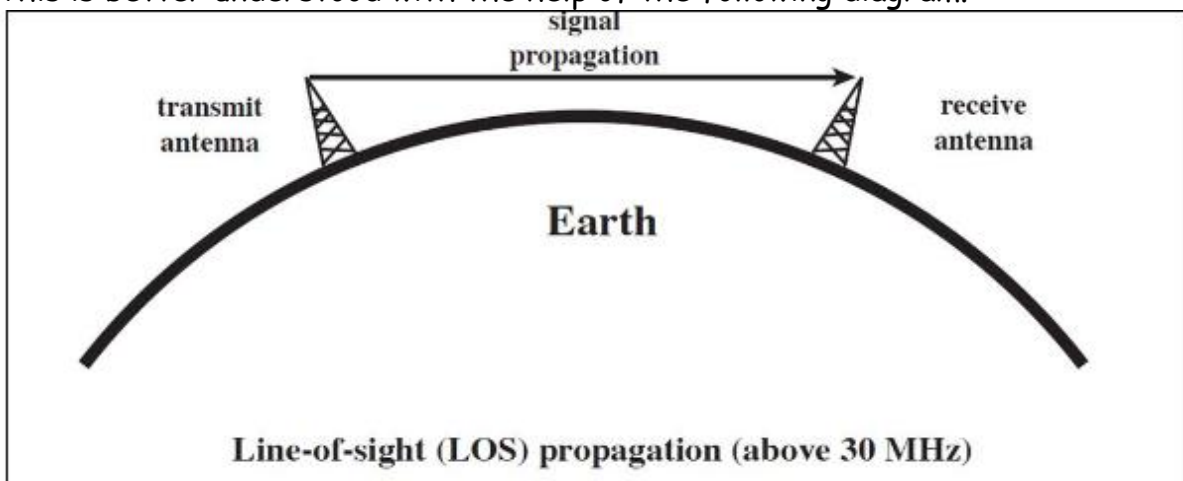

The figure depicts this mode of propagation very clearly. The line-of-sight propagation will not be smooth if there occurs any obstacle in its transmission path. As the signal can travel only to lesser distances in this mode, this transmission is used for **infrared** or **microwave transmissions**.